



Quick Installation Guide

Cloud AP Controller



WI-AC150

www.wireless-tek.com

1.Packing Content

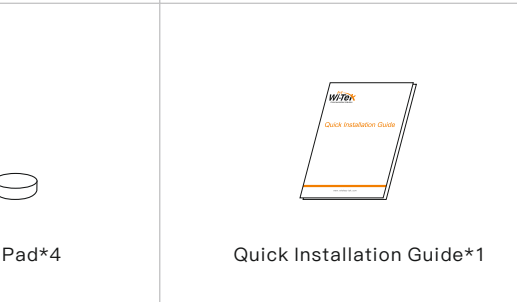
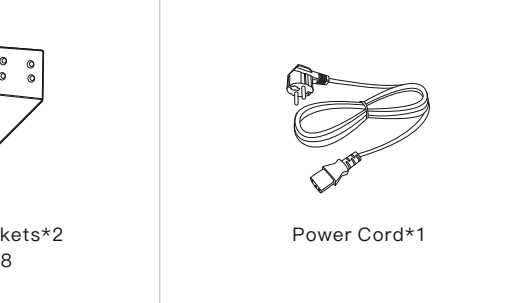
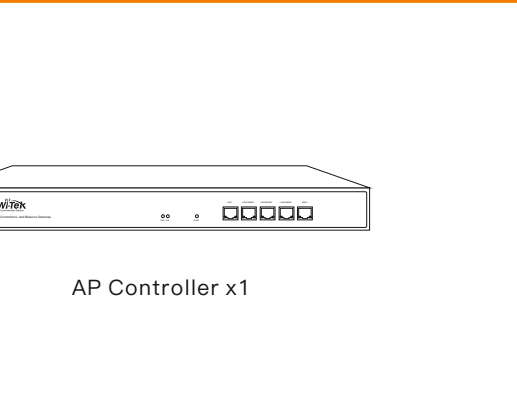

2. Appearance Overview

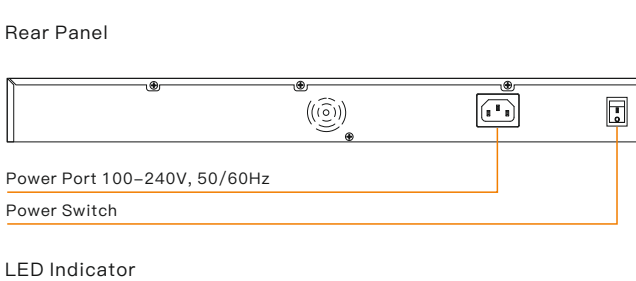
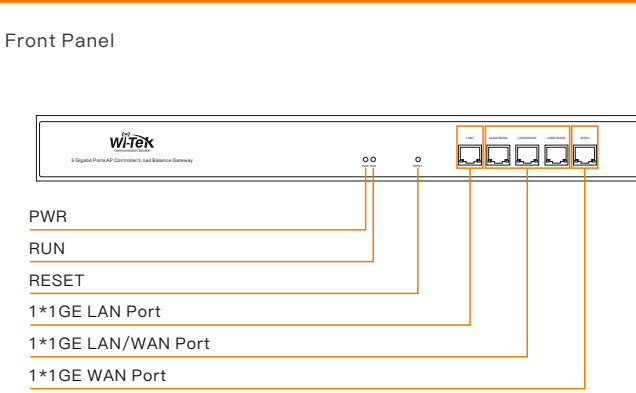

• LED Indicator

Item	Description
PWR	The green light indicates that the device has power input.
RUN	The green light indicates that the device is power on and working normally.

• Port and Button

Item	Description
LAN	10/100/1000Mbps auto-negotiation RJ45 ports for connecting to Ethernet devices.
WAN	10/100/1000Mbps auto-negotiation RJ45 ports for connecting to ISP.
RESET	Press for more than 8 seconds to restore the gateway to factory.

3. Installation

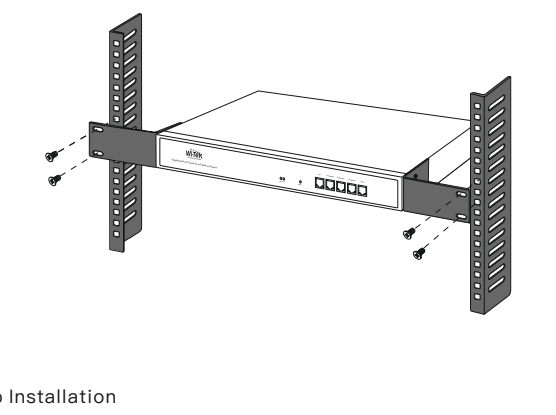
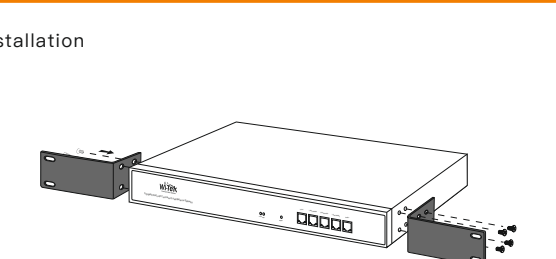

4.Configuration

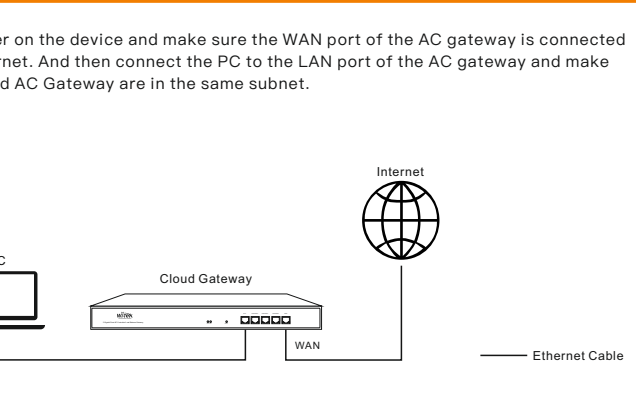

Step1: Launch a web browser and type **192.168.10.1** in the address bar, then press Enter (Windows) or Return (Mac).

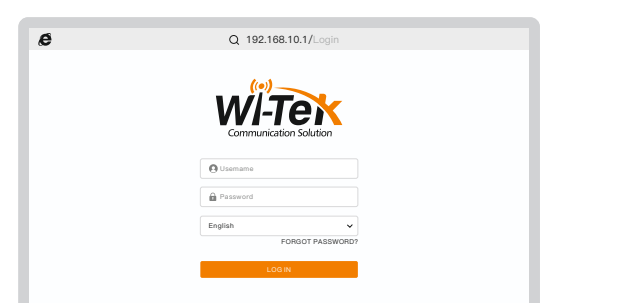

5.Cloud management settings

Step2: After entering the default login account password "admin", the system will prompt you to modify your user password to enhance security.

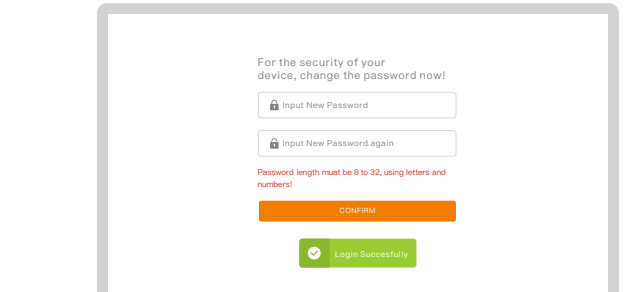

Step3: Go to the AP List tab and devices which have been discovered by the AC are displayed. Follow the following procedure to bind AP.

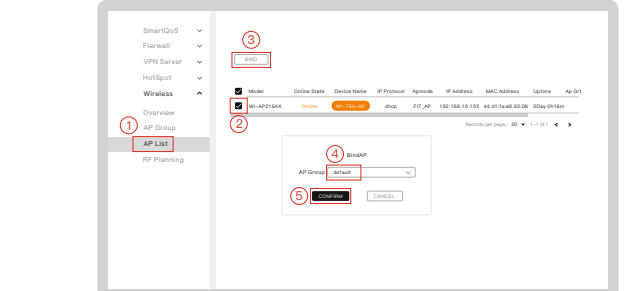

5.Cloud management settings

Note: The AC Gateway must be connected to the internet to bind successfully
 Step 1 Launch your web browser then enter <http://cloud2.wireless-tek.com> in the address bar.
 Step 2 Register an account password by user name or email.
 Step 3 log in to the cloud account with the account password after registration.

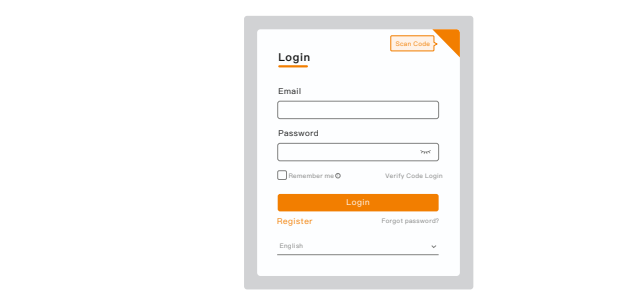

After the login is successful, the steps to bind the device on the cloud account are as follows:

(1) Click ADD NETWORK

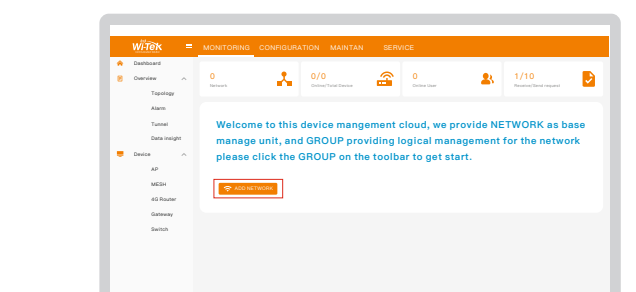

5.Cloud management settings

(2) Fill in the group name and location, click save.

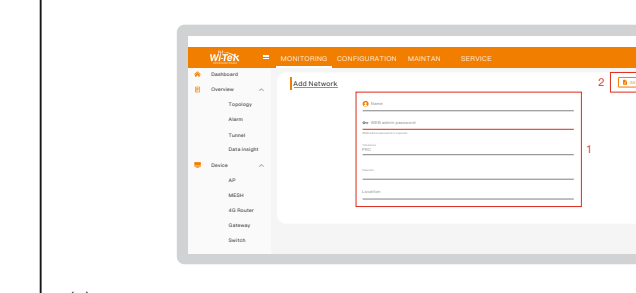

(3) And click next.

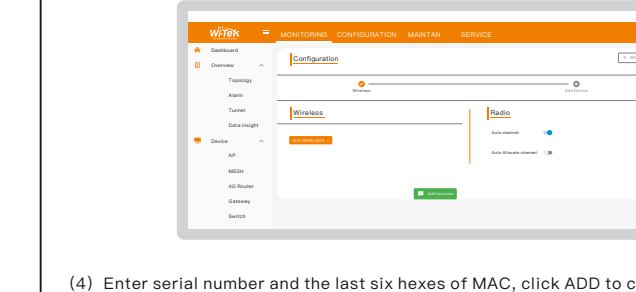

(4) Enter serial number and the last six hexes of MAC, click ADD to create and click SAVE, and the configuration is completed.

Note: The 17-digit SN code of the device is shown on the bottom of the device.

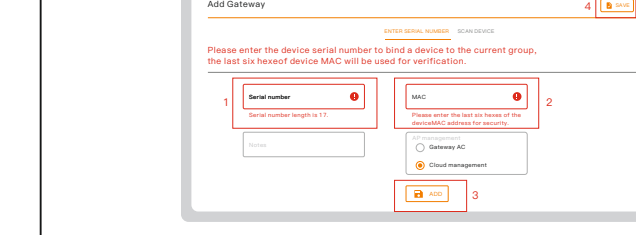

5.Cloud management settings

(5) In the relevant device options, you can see the bound device information.

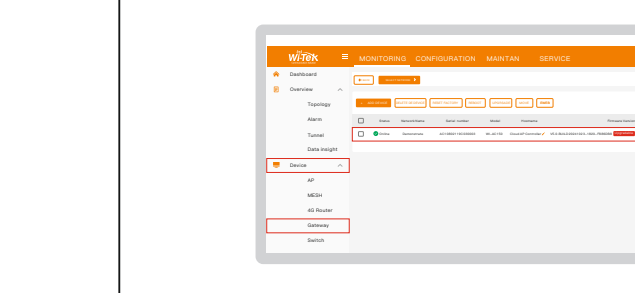

(6) Click Tunnel, Select binding device type, click EWEB to log in to the device.

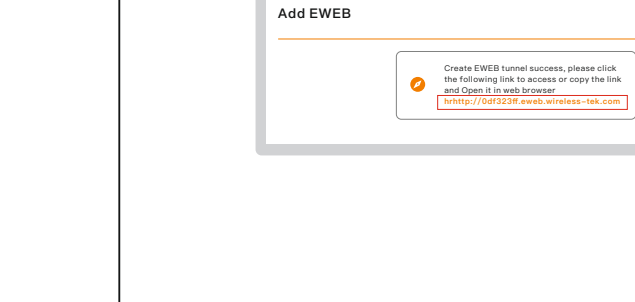
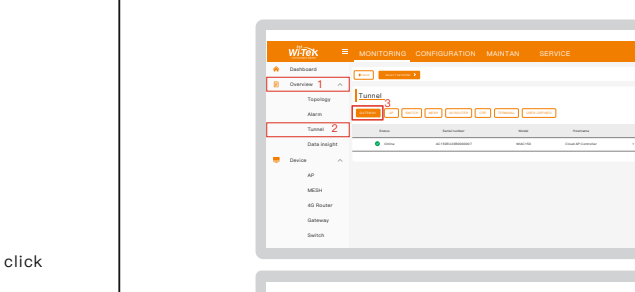

Warranty Card

Username	
Address	
Telephone No.	
Purchase Shop	
Purchase Address	
Product Model No.	
Purchase Time	
Serial No.	
Dealer Signature	

- If the product defects within the warranty period, we will provide professional maintenance service.
- Proof of purchase and a complete product serial number are required to receive any services guaranteed as part of the limited warranty.
- Any other defects that are not caused by workmanship or product quality, such as natural disasters, water damage, extreme thermal or environmental conditions, sticker damaged, warranty card loss will disqualify the product from limited warranty.



Wireless-Tek Technology Limited
 Address: Building 3, Units 1801-1807, 1812, Huaqiang Era Plaza, Tangwei Community, Fuhai Street, Bao'an District, Shenzhen City, Guangdong Province, China.
 Website: www.wireless-tek.com
 Tel: 86-0755-32811290
 Email: sales@wireless-tek.com
 Technical Support: tech@wireless-tek.com

