

Quick Installation Guide

Wi-Tek 250 Meters Economic CCTV PoE Switch

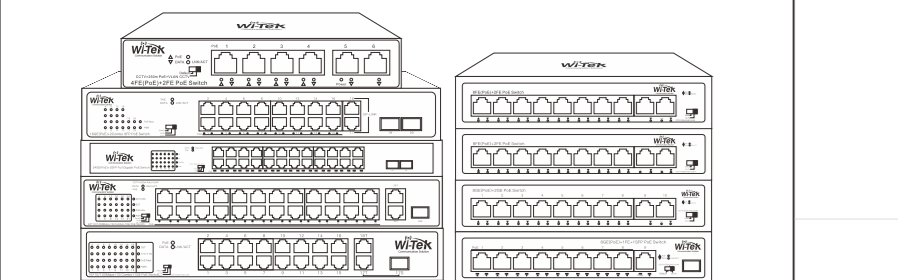

WI-PS205H | WI-PS210H | WI-PS518GH | WI-PS526GH | WI-PS305GH | WI-PS308GH | WI-PS309GFH | WI-PS318GFH | WI-PS326GFH

1. Packing Content

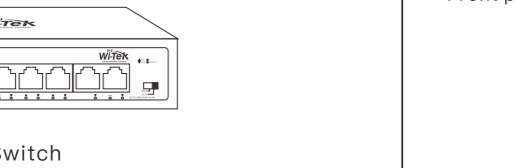

1 x Switch

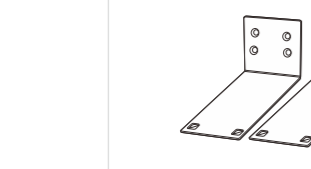

1 x Power Cord

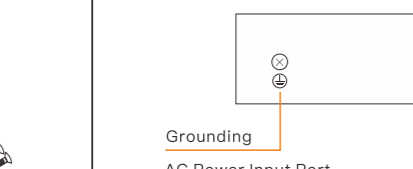

1 x Rack mount kit
(Only for WI-PS518GH WI-PS526GH WI-PS318GFH WI-PS326GFH)

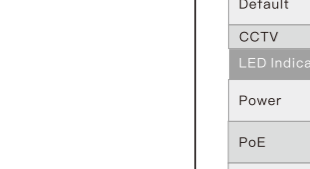

1 x Installation guide

2. Appearance Overview

WI-PS205H

• Front panel

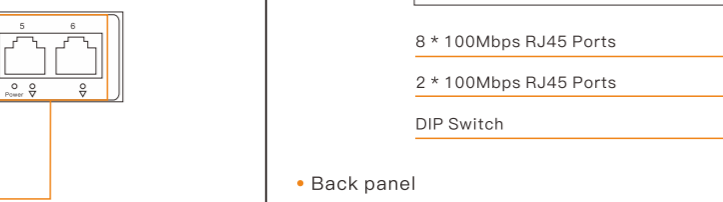

• Back panel

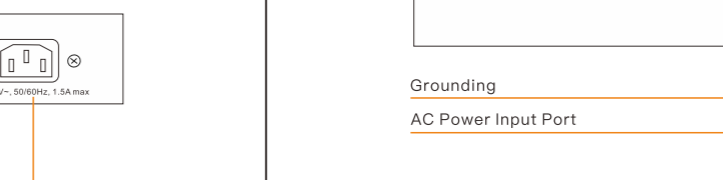

• LED indicator and button

WI-PS205H DIP Switch Description	
Default	The transmission distance of PoE port can be up to 100m with 100Mbps and disable Port Isolation, Watchdog
CCTV	Enable Port Isolation and Watchdog mode, PoE transmit 250 meters with 10Mbps
LED Indicators	Description
Power	On: The device power on is normal Off: The device is power off or failed
PoE	On: PoE is working Off: PoE is not working
DATA	On: Port connected Blinking: Data transmission Off: Port disconnected

Note: PoE Watchdog -All PoE ports enable PoE watchdog function, which can detect and reboot the offline compliant PoE powered devices. Opening and closing PoE watchdog function: Closed by default, watchdog is turned on in CCTV mode

WI-PS518GH

• Front panel

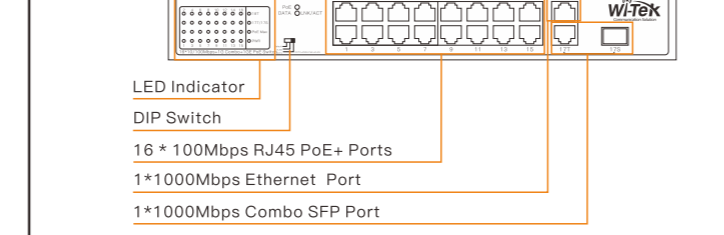

• Back panel

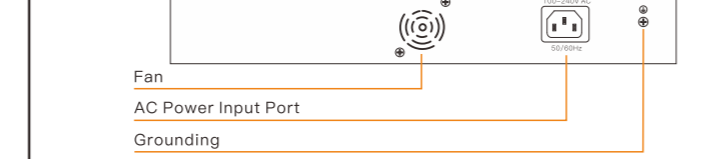

• LED indicator and button

WI-PS518GH DIP Switch Description	
Default	The transmission distance of PoE port can be up to 100m with 100Mbps and disable Port Isolation, Watchdog
VLAN	Enable Port Isolation and Watchdog mode, PoE port just can send data to Up-link, port PoE transmit 100 meters with 100Mbps
CCTV	Enable Port Isolation and Watchdog mode, PoE transmit 250 meters with 10Mbps
LED Indicators	Description
Power	On: The device power on is normal Off: The device is power off or failed
DATA	Blinking: Data transmission is active and working
PoE	On: PoE is working Off: PoE is not working
LNK/ACT	On: Data on TX/RX Off: Ports link down
PoE Max	When total PoE output power > Power Budget * 80%, the LED light will be on
25T	On: Port 25 link up Off: Port 25 link down
17T/17S	On: Port 17/17S link up Off: Port 17/17S link down
26T/26S	On: Port 26T/26S link up Off: Port 26T/26S link down

Note: PoE Watchdog -All PoE ports enable PoE watchdog function, which can detect and reboot the offline compliant PoE powered devices. Opening and closing PoE watchdog function: Closed by default, watchdog is turned on in VLAN and CCTV modes

WI-PS526GH

• Front panel



• Back panel



• LED indicator and button

WI-PS526GH DIP Switch Description	
Default	The transmission distance of PoE port can be up to 100m with 100Mbps and disable Port Isolation, Watchdog
VLAN	Enable Port Isolation and Watchdog mode, PoE port just can send data to Up-link, port PoE transmit 100 meters with 100Mbps
CCTV	Enable Port Isolation and Watchdog mode, PoE transmit 250 meters with 10Mbps
LED Indicators	Description
Power	On: The device power on is normal Off: The device is power off or failed
DATA	Blinking: Data transmission is active and working
PoE	On: PoE is working Off: PoE is not working
LNK/ACT	On: Data on TX/RX Off: Ports link down
PoE Max	When total PoE output power > Power Budget * 80%, the LED light will be on
25T	On: Port 25 link up Off: Port 25 link down
26T/26S	On: Port 26T/26S link up Off: Port 26T/26S link down

Note: PoE Watchdog -All PoE ports enable PoE watchdog function, which can detect and reboot the offline compliant PoE powered devices. Opening and closing PoE watchdog function: Closed by default, watchdog is turned on in VLAN and CCTV modes

WI-PS305GH

• Front panel

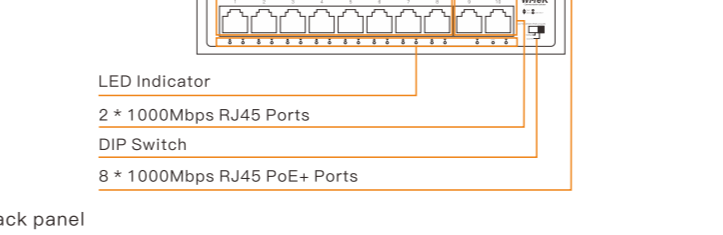

• Back panel

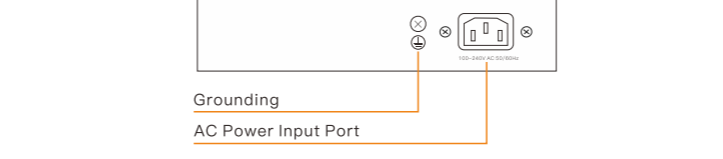

• LED indicator and button

WI-PS305GH DIP Switch Description	
Default	The transmission distance of PoE port can be up to 100m with 1000Mbps and disable Port Isolation, Watchdog
CCTV	Enable Port Isolation and Watchdog mode, PoE transmit 250 meters with 10Mbps
LED Indicators	Description
Power	On: The device power on is normal Off: The device is power off or failed
DATA	Blinking: Data transmission is active and working
PoE	On: PoE is working Off: PoE is not working
LNK/ACT	On: Data on TX/RX Off: Ports link down

Note: PoE Watchdog -All PoE ports enable PoE watchdog function, which can detect and reboot the offline compliant PoE powered devices. Opening and closing PoE watchdog function: Closed by default, watchdog is turned on in VLAN and CCTV mode

WI-PS308GH

• Front panel

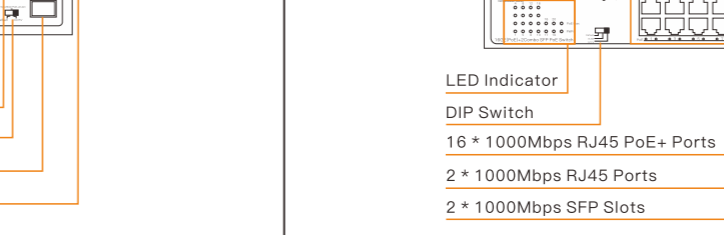

• Back panel



• LED indicator and button

WI-PS308GH DIP Switch Description	
Default	The transmission distance of PoE port can be up to 100m with 1000Mbps and disable Port Isolation, Watchdog
CCTV	Enable Port Isolation and Watchdog mode, PoE transmit 250 meters with 10Mbps
LED Indicators	Description
Power	On: The device power on is normal Off: The device is power off or failed
DATA	Blinking: Data transmission is active and working
PoE	On: PoE is working Off: PoE is not working
LNK/ACT	On: Data on TX/RX Off: Ports link down

Note: PoE Watchdog -All PoE ports enable PoE watchdog function, which can detect and reboot the offline compliant PoE powered devices. Opening and closing PoE watchdog function: Closed by default, watchdog is turned on in VLAN and CCTV modes

WI-PS309GFH

• Front panel

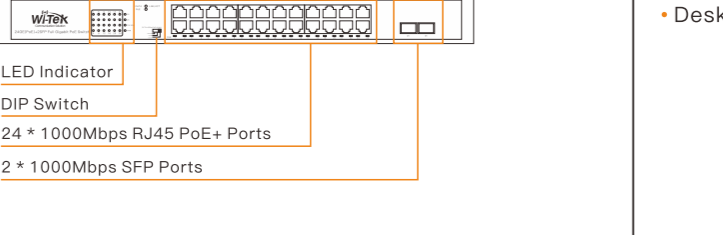

• Back panel

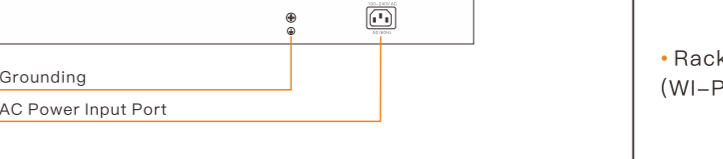

• LED indicator and button

WI-PS309GFH DIP Switch Description	
Default	The transmission distance of PoE port can be up to 100m with 1000Mbps and disable Port Isolation, Watchdog
CCTV	Enable Port Isolation and Watchdog mode, PoE transmit 250 meters with 10Mbps
LED Indicators	Description
Power	On: The device power on is normal Off: The device is power off or failed
DATA	Blinking: Data transmission is active and working
PoE	On: PoE is working Off: PoE is not working
LNK/ACT	On: Data on TX/RX Off: Ports link down
PoE Max	When total PoE output power > Power Budget * 80%, the LED light will be on

Note: PoE Watchdog -All PoE ports enable PoE watchdog function, which can detect and reboot the offline compliant PoE powered devices. Opening and closing PoE watchdog function: Closed by default, watchdog is turned on in VLAN and CCTV modes

WI-PS318GFH

• Front panel

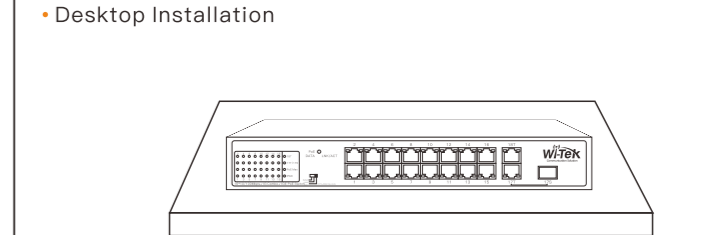

• Back panel

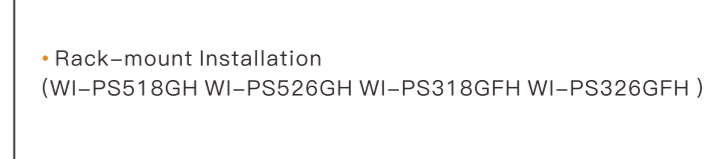

• LED indicator and button

WI-PS318GFH DIP Switch Description	
Default	The transmission distance of PoE port can be up to 100m with 1000Mbps and disable Port Isolation, Watchdog
VLAN	Enable Port Isolation and Watchdog mode, PoE port just can send data to Up-link, port PoE transmit 100 meters with 100Mbps
CCTV	Enable Port Isolation and Watchdog mode, PoE transmit 250 meters with 10Mbps
LED Indicators	Description
Power	On: The device power on is normal Off: The device is power off or failed
DATA	Blinking: Data transmission is active and working
PoE	On: PoE is working Off: PoE is not working
LNK/ACT	On: Data on TX/RX Off: Ports link down
PoE Max	When total PoE output power > Power Budget * 80%, the LED light will be on

Note: PoE Watchdog -All PoE ports enable PoE watchdog function, which can detect and reboot the offline compliant PoE powered devices. Opening and closing PoE watchdog function: Closed by default, watchdog is turned on in VLAN and CCTV modes

WI-PS326GFH

• Front panel

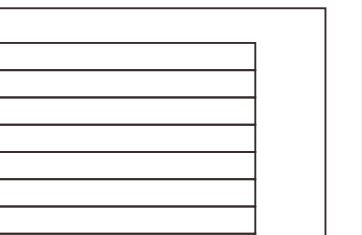

• Back panel

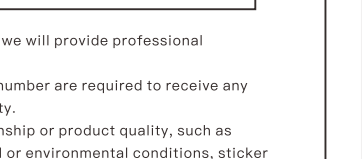

• LED indicator and button

WI-PS326GFH DIP Switch Description	
Default	The transmission distance of PoE port can be up to 100m with 1000Mbps and disable Port Isolation, Watchdog
VLAN	Enable Port Isolation and Watchdog mode, PoE port just can send data to Up-link, port PoE transmit 100 meters with 100Mbps
CCTV	Enable Port Isolation and Watchdog mode, PoE transmit 250 meters with 10Mbps
LED Indicators	Description
Power	On: The device power on is normal Off: The device is power off or failed
DATA	Blinking: Data transmission is active and working
PoE	On: PoE is working Off: PoE is not working
LNK/ACT	On: Data on TX/RX Off: Ports link down
PoE Max	When total PoE output power > Power Budget * 80%, the LED light will be on

Note: PoE Watchdog -All PoE ports enable PoE watchdog function, which can detect and reboot the offline compliant PoE powered devices. Opening and closing PoE watchdog function: Closed by default, watchdog is turned on in VLAN and CCTV modes

3. Installation

• Desktop Installation

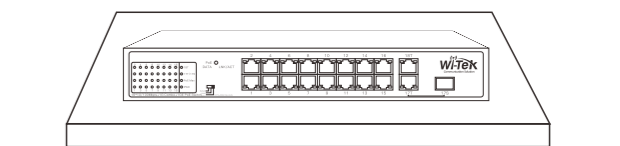

• Rack-mount Installation

(WI-PS518GH WI-PS526GH WI-PS318GFH WI-PS326GFH)

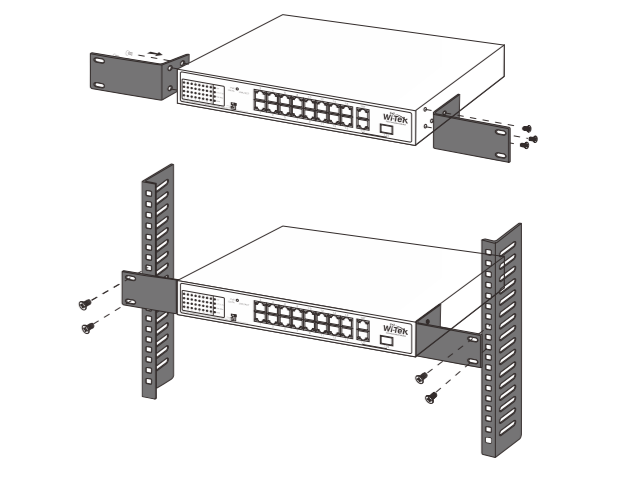

Warranty Card

Username	
Address	
Telephone No.	
Purchase Shop	
Purchase Address	
Product Model No.	
Purchase Time	
Serial No.	
Dealer Signature	

• If the product defects within the warranty period, we will provide professional maintenance service.
• Proof of purchase and a complete product serial number are required to receive any services guaranteed as part of the limited warranty.
• Any other defects that are not caused by workmanship or product quality, such as natural disasters, water damage, extreme thermal or environmental conditions, sticker damaged, warranty card loss will disqualify the product from limited warranty.



Wireless-Tek Technology Limited
Address: Building 3, Units 1801-1807, 1812, Huangiang Era Plaza, Tangwel Community, Fuhai Street, Bao'an District, Shenzhen City, Guangdong Province, China.
Website: www.wireless-tek.com
Tel: 86-0755-32811290
Email: sales@wireless-tek.com
Technical Support: tech@wireless-tek.com

