

Quick Installation Guide

Waterproof Industrial PoE Extender

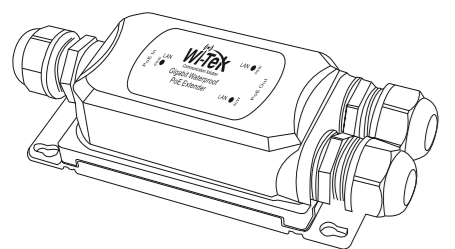

WI-POE21E-O | WI-POE22E-O

1. Package Contents

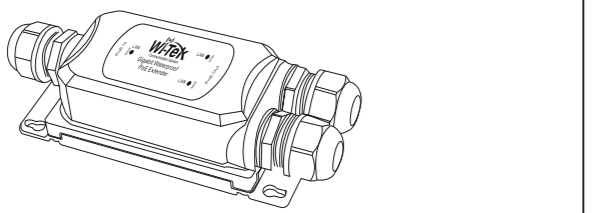

1 x Device



3 x M22 Waterproof Gland



1 x Wrench



1 x Ground Wire

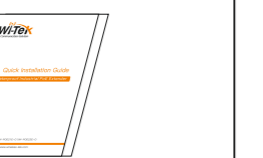

1 x Quick Installation Guide

2. Hardware Introduction

2.1 Product Outlook

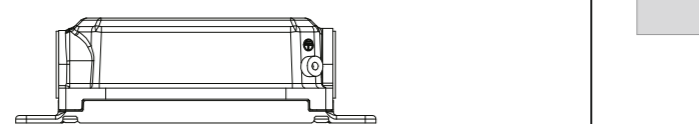
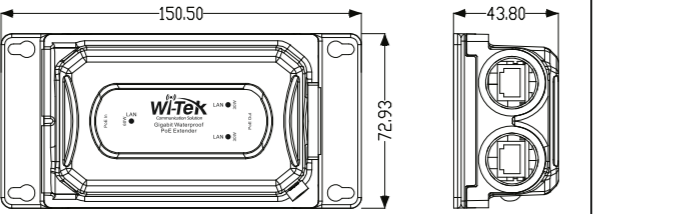
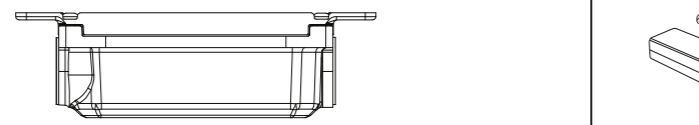

Unit: mm

3. Appearance Overview

• WI-POE21E-O

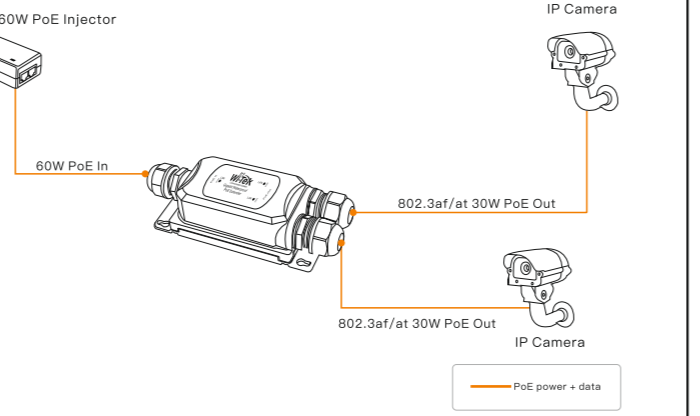

LED	Color	Status	Description
LAN	Green	On	Link established
		Off	No device connection
		Blink	Data and power are transmitting

• WI-POE22E-O

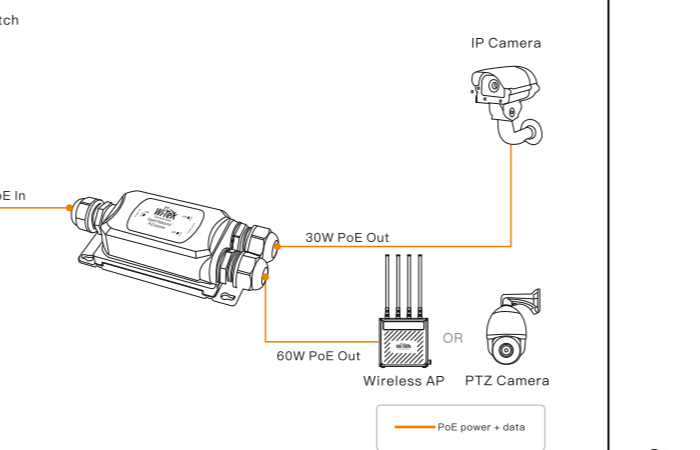

LED	Color	Status	Description
LAN	Green	On	Link established
		Off	No device connection
		Blink	Data and power are transmitting

4. Accessories Installation

Step 1: Disassemble the waterproof gland



Step 2: Turn the body of waterproof gland to the RJ45 ports and tighten it by the wrench. Pick a cable and run through the sealing insert and clamping nut.

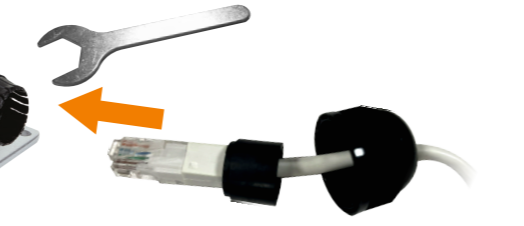

5. Hardware Installation

Step 3: Plug the cable into the port.



Step 4: Insert the sealing insert to the waterproof gland body.



Step 5: Attach the clamping nut to the waterproof gland to complete assembly.

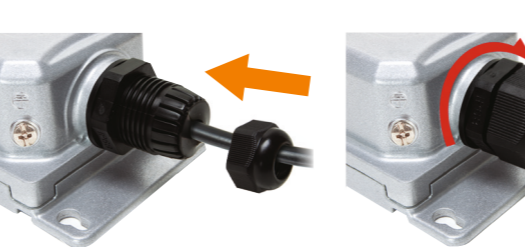

Step 6: Check it and make sure it is tightly install.



Step 7: Repeat Step 1 to Step 6 for other ports.

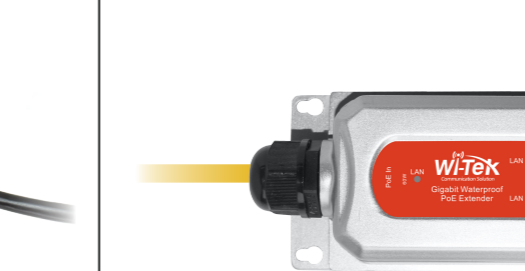
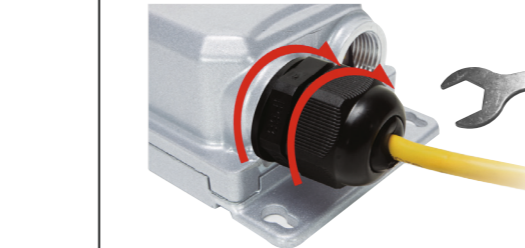

Warranty Card

Username	
Address	
Telephone No.	
Purchase Shop	
Purchase Address	
Product Model No.	
Purchase Time	
Serial No.	
Dealer Signature	

- If the product defects within the warranty period, we will provide professional maintenance service.
- Proof of purchase and a complete product serial number are required to receive any services guaranteed as part of the limited warranty.
- Any other defects that are not caused by workmanship or product quality, such as natural disasters, water damage, extreme thermal or environmental conditions, sticker damaged, warranty card loss will disqualify the product from limited warranty.



Wireless-Tek Technology Limited
 Address: Building 3, Units 1801-1807, 1812, Huaqiang Era Plaza, Tangwei Community, Fuhai Street, Bao'an District, Shenzhen City, Guangdong Province, China.
 Website: www.wireless-tek.com
 Tel: 86-0755-32811290
 Email: sales@wireless-tek.com
 Technical Support: tech@wireless-tek.com

